

XA $\dot{\iota}$ series

the *intelligent* pump - SAE version

fixed displacement bent axis design



The compact size envelope of XA $\dot{\iota}$ pumps, together with their technology, means they can be installed in environments with little space available, and be used at relatively high rotating speeds.

ADVANTAGES

- ▶ Pump automatically sets to required direction of rotation
- ▶ Mounting and start-up, easier than ever !

CHARACTERISTICS

- 7 pistons
- original idea for plate - barrel synchronisation
- use of materials with high mechanical resistance
- reinforced sealing

■ 10 models:

- from 18 to 63 cc/rev (1.1 to 3.84 cu.in/rev)
- 380 bar (5511 psi) continuous working pressure
- 420 bar (6092 psi) peak pressure
- maximum speed from 2300 to 2900 rpm

4 bolt
flange models

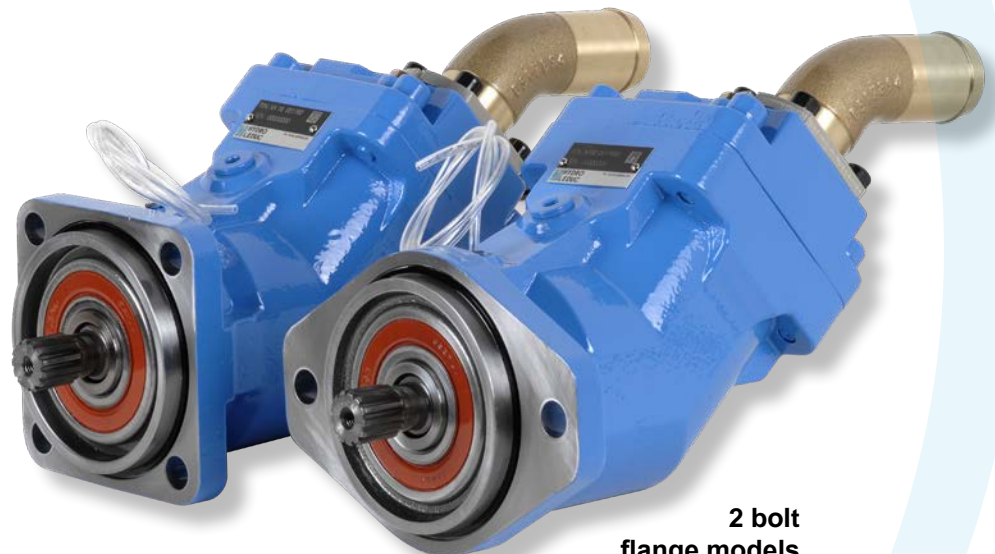

2 bolt
flange models

Characteristics - XAi SAE version

► 2 bolt flange - SAE J744

Pump reference	Displac. Cu.in/rev (cc/rev)	Maximum continuous pressure psi (bar)	Maximum peak pressure < 5 seconds psi (bar)	Max speed ⁽¹⁾ rpm	Max. torque absorbed at 5511 psi (380 bar) ⁽²⁾ lbf ft (N.m)	Weight		Overhang torque	
						without inlet fitting lbs (kg)	with inlet fitting 2" lbs (kg)	without inlet fitting lbf ft (N.m)	with inlet fitting 2" lbf ft (N.m)
XAi 18 0524085	1.1 (18)	5511 (380)	6092 (420)	2900	84 (114)	22.15 (10.5)	23.14 (10.5)	7.04 (9.54)	7.35 (9.97)
XAi 25 0524095	1.52 (25)	5511 (380)	6092 (420)	2750	117 (159)	22.38 (10.15)	23.36 (10.6)	7.11 (9.64)	7.43 (10.07)
XAi 32 0524105	1.95 (32)	5511 (380)	6092 (420)	2700	150 (204)	26.34 (11.95)	27.67 (12.4)	8.81 (11.95)	9.15 (12.4)
XAi 41 0524115	2.5 (41)	5511 (380)	6092 (420)	2550	192 (261)	26.45 (12)	27.45 (12.45)	8.85 (12)	9.18 (12.45)

(1) At absolute pressure 14.50 psi (1 bar), ISO VG46 fluid at 77°F (25°C).

(2) Maximum torque given with a mechanical efficiency at 95%.

► 4 bolt flange - SAE J744

Pump reference	Displac. Cu.in/rev (cc/rev)	Maximum continuous pressure psi (bar)	Maximum peak pressure < 5 seconds psi (bar)	Max speed ⁽¹⁾ rpm	Max. torque absorbed at 5511 psi (380 bar) ⁽²⁾ lbf ft (N.m)	Weight		Overhang torque	
						without inlet fitting lbs (kg)	with inlet fitting 2" lbs (kg)	without inlet fitting lbf ft (N.m)	with inlet fitting 2" lbf ft (N.m)
XAi 18 0524080	1.1 (18)	5511 (380)	6092 (420)	2900	84 (114)	22.59 (10.25)	23.59 (10.7)	7.18 (9.73)	7.49 (10.16)
XAi 25 0524090	1.52 (25)	5511 (380)	6092 (420)	2750	117 (159)	22.71 (10.3)	23.70 (10.75)	7.19 (9.75)	7.53 (10.21)
XAi 32 0524100	1.95 (32)	5511 (380)	6092 (420)	2700	150 (204)	26.68 (12.1)	27.67 (12.55)	8.92 (12.1)	9.26 (12.55)
XAi 41 0524110	2.5 (41)	5511 (380)	6092 (420)	2550	192 (261)	26.78 (12.15)	27.78 (12.6)	8.96 (12.15)	9.29 (12.6)
XAi 50 0524360 XAi 50 0524365	3.07 (50.3)	5511 (380)	6092 (420)	2450	234 (318)	26.89 (12.2)	27.89 (12.65)	9.45 (12.81)	9.80 (13.28)
XAi 63 0524125	3.84 (63)	5511 (380)	6092 (420)	2300	295 (401)	27.01 (12.25)	28 (12.7)	9.49 (12.86)	9.83 (13.33)

(1) At absolute pressure 14.50 psi (1 bar), ISO VG46 fluid at 77°F (25°C).

(2) Maximum torque given with a mechanical efficiency at 95%.

DUAL DIRECTION OF ROTATION:
this *intelligent* pump can operate in either direction of rotation.

Fit the inlet fitting on required side, depending on the direction of rotation of the PTO, and the pump will set itself accordingly.



Clockwise (CW)

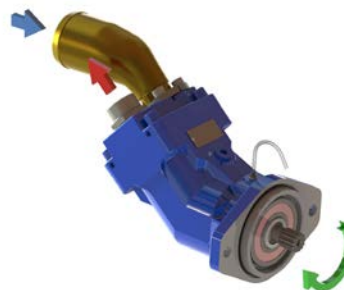

Counter-clockwise (CCW)

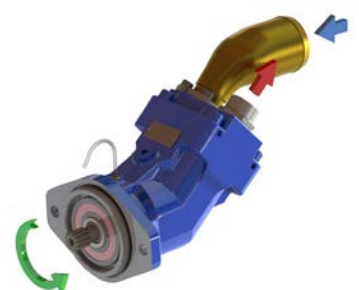

When the PTO turns counter-clockwise, the pump has to turn clockwise.

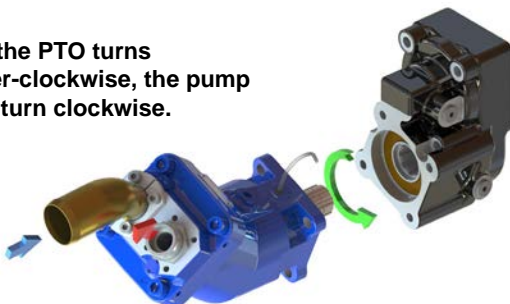

When the PTO turns clockwise, the pump has to turn counter-clockwise.

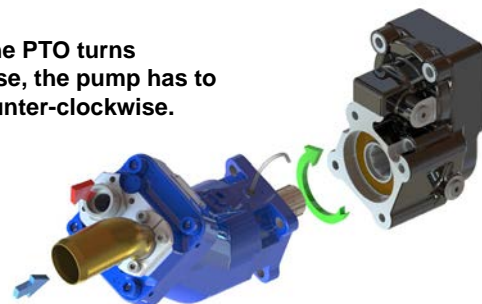

XAi SAE version - Dimensions

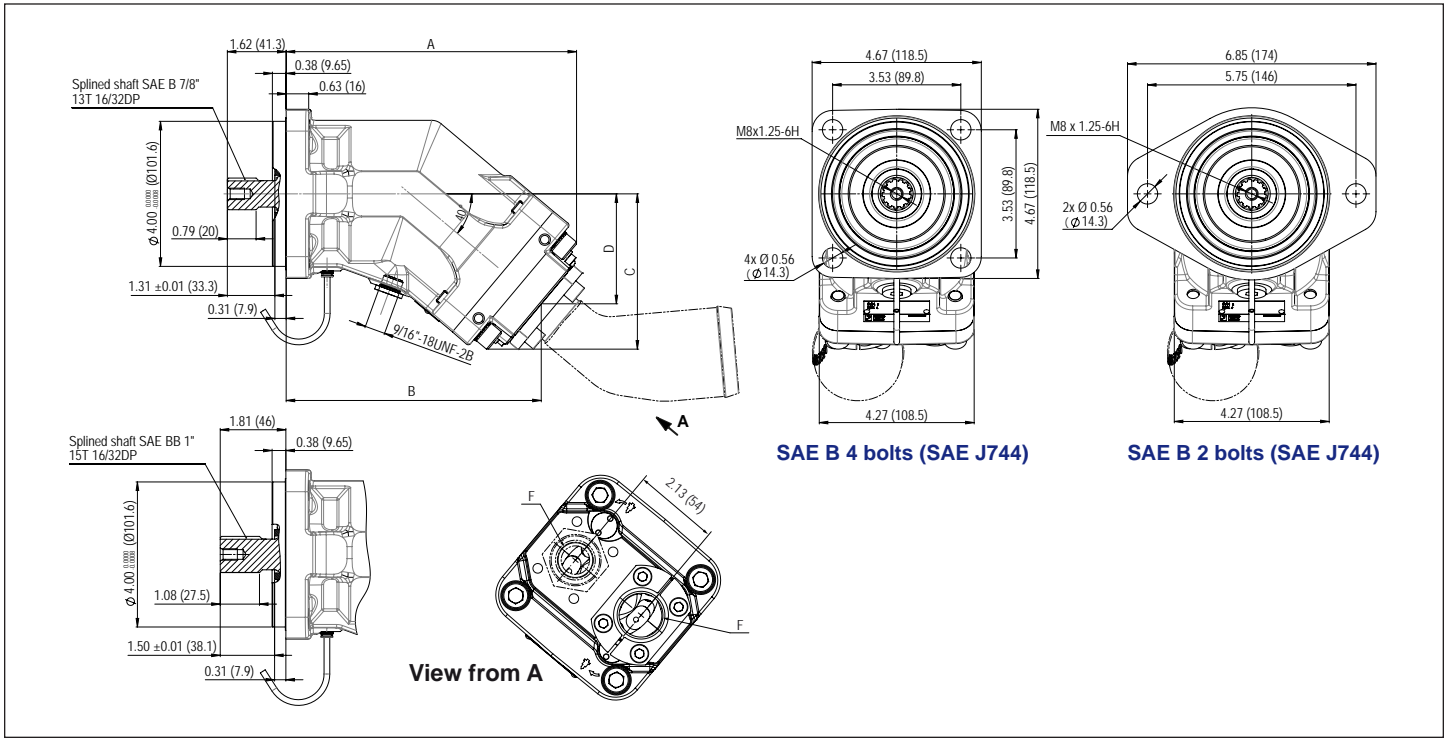

► SAE B - 2 bolt mounting configurations (SAE J744)

Pump type	A	B	C	D	F	Shaft
XAi 18 0524085	7.76 (197.2)	6.79 (172.5)	4.08 (103.7)	2.87 (73)	3/4"-16 UNF-2B	SAE B 7/8" 13T-16/32DP
XAi 25 0524095	7.76 (197.2)	6.79 (172.5)	4.08 (103.7)	2.87 (73)	3/4"-16 UNF-2B	SAE B 7/8" 13T-16/32DP
XAi 32 0524105	8 (203.2)	7.03 (178.5)	4.28 (108.7)	3.03 (77)	3/4"-16 UNF-2B	SAE B 7/8" 13T-16/32DP
XAi 41 0524115	8 (203.2)	7.03 (178.5)	4.28 (108.7)	3.03 (77)	1 1/16"-12 UNF-2B	SAE B 7/8" 13T-16/32DP

► SAE B - 4 bolt mounting configurations (SAE J744)

Pump type	A	B	C	D	F	Shaft
XAi 18 0524080	7.76 (197.2)	6.79 (172.5)	4.08 (103.7)	2.87 (73)	3/4"-16 UNF-2B	SAE B 7/8" 13T-16/32DP
XAi 25 0524090	7.76 (197.2)	6.79 (172.5)	4.08 (103.7)	2.87 (73)	3/4"-16 UNF-2B	SAE B 7/8" 13T-16/32DP
XAi 32 0524100	8 (203.2)	7.02 (178.5)	4.28 (108.7)	3.03 (77)	3/4"-16 UNF-2B	SAE B 7/8" 13T-16/32DP
XAi 41 0524110	8 (203.2)	7.02 (178.5)	4.28 (108.7)	3.03 (77)	1 1/16"-12 UNF-2B	SAE B 7/8" 13T-16/32DP
XAi 50 0524360	8.45 (214.7)	7.48 (190)	4.65 (118.2)	3.4 (86.5)	1 1/16"-12 UNF-2B	SAE B 7/8" 13T-16/32DP
XAi 50 0524365	8.45 (214.7)	7.48 (190)	4.65 (118.2)	3.4 (86.5)	1 1/16"-12 UNF-2B	SAE BB 1" 15T-16/32DP
XAi 63 0524125	8.45 (214.7)	7.48 (190)	4.65 (118.2)	3.4 (86.5)	1 1/16"-12 UNF-2B	SAE BB 1" 15T-16/32DP

Dimensions in inches (mm).

► Torque absorbed as a function of pump output pressure (with a mechanical efficiency considered at 95%)

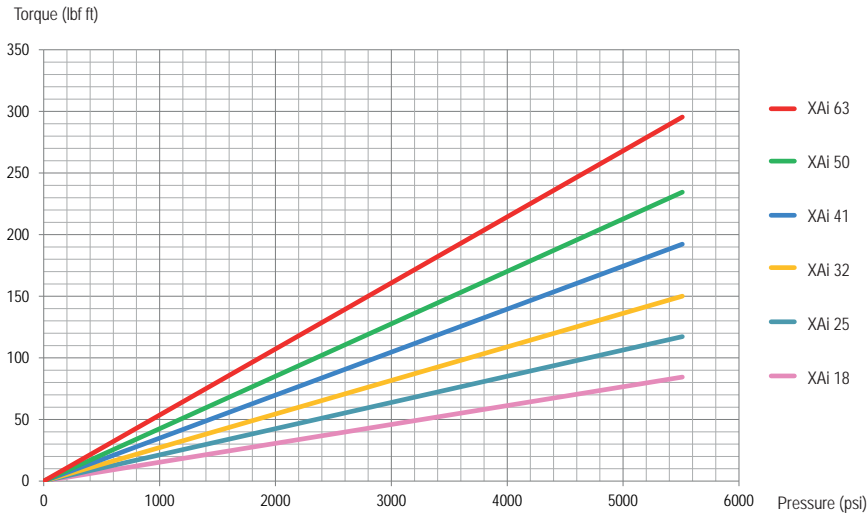

$$C = \frac{Cyl \times \Delta P}{62.8 \times \eta_{meca}}$$

With:

- C = Torque in lbf ft
- Cyl = Displacement in cu.in/rev
- ΔP = Differential pressure in psi
- η_{meca} = Mechanical efficiency

► Flow as a function of rotating speed

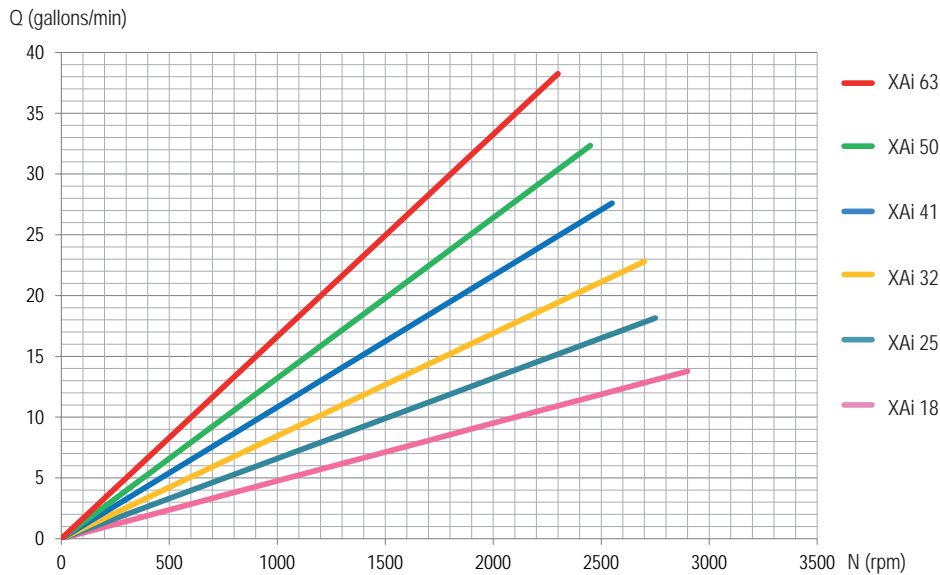

$$Q = \frac{Cyl \times N \times \eta_{Vol}}{1000}$$

With:

- Q = Flow in gal/min
- N = Speed in rpm
- η_{Vol} = Volumetric efficiency
- Cyl = Displacement in cu.in/rev

These graphs are the results of testwork done in HYDRO LEDUC R&D laboratory, on a specific test bench with a mineral hydraulic fluid ISO VG46 at 77°F (25°C) (~100 cSt) - disregarding the volumetric efficiency.

► Volumetric efficiency

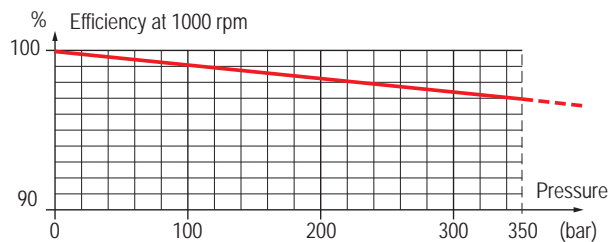



INLET FITTINGS FOR XAi PUMPS

⚠ See recommendations of the hosing dimensions on page 42.

For high speeds, please consult.

All XAi pumps are supplied with their inlet fitting.

Please specify required fitting from the choice below when ordering.

45° elbow fittings kit

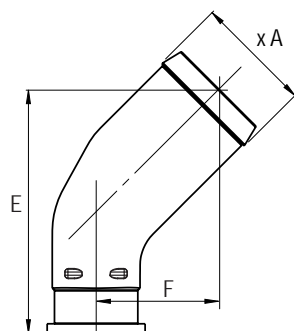

Reference	Ø hose	Ø A	E	F
0519370	1 1/2"	1.54 (39.1)	3.61 (91.7)	1.84 (46.7)
0519373	42	1.69 (43)	3.61 (91.7)	1.84 (46.7)
0519374	1 3/4"	1.81 (46)	3.61 (91.7)	1.84 (46.7)
0519371	2"	2.04 (51.8)	4.27 (108.4)	2.14 (54.4)
0519372	2 1/2"	2.54 (64.5)	4.93 (125.2)	2.45 (62.2)

Dimensions in inches (mm).

90° elbow fittings kit

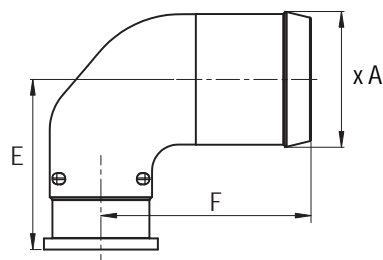

Reference	Ø hose	Ø A	E	F
0521740	1 1/2"	1.54 (39.1)	2.31 (58.6)	3.13 (79.5)
0521741	2"	2.04 (51.8)	2.56 (64.9)	3.16 (80.2)
0521742	2 1/2"	2.54 (64.5)	2.81 (71.3)	3.44 (87.5)

Dimensions in inches (mm).

BY-PASS VALVE FOR XAi PUMPS

For XAi pump applications where the pump is driven by a continuous running PTO (PTO which cannot be disengaged), this solution allows the continuous running of the pump:

- without creating problems of fluid overheating;
- without affecting pump service life;
- with no modifications necessary to the hydraulic circuit of the equipment.

⇒ **By-pass fitted on the back of the XAi pump.**

Codes LEDUC	24 Volts
XAi 18 to XAi 32	BPA32 0521710
XAi 41 to XAi 63	BPA63 0521715

► How does it work ?

The by-pass valve is a 24 Volts solenoid valve.

When not activated, it enables pump output to link up to pump inlet.

When it is activated, the pump operates normally (output flow).

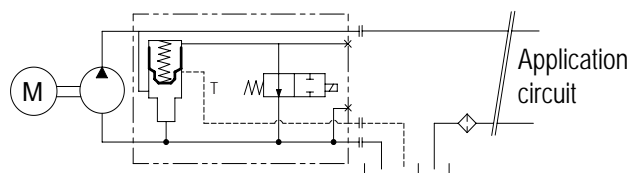
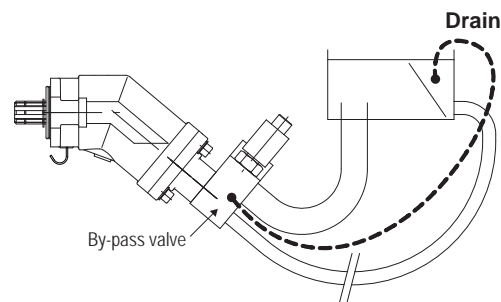

A drain line has to be installed between the By-Pass valve and the hydraulic tank of the vehicle to ensure sufficient oil circulation and a good cooling into the pump. In any case, the connection to the tank must be done below the oil level.

► XAi overhang torque with by-pass

2 bolt flange - SAE J744

Pump reference	Weight		Overhang torque	
	without inlet fitting lbs (kg)	with inlet fitting 2" lbs (kg)	without inlet fitting lbf ft (N.m)	with inlet fitting 2" lbf ft (N.m)
XAi 18 - 2 bolts	28.33 (12.85)	29.32 (13.30)	9.87 (13.38)	12.51 (16.96)
XAi 25 - 2 bolts	28.44 (12.90)	29.43 (13.35)	12.13 (16.45)	12.55 (17.02)
XAi 32 - 2 bolts	32.41 (14.70)	33.40 (15.15)	14 (18.98)	14.43 (19.56)
XAi 41 - 2 bolts	32.52 (14.75)	33.51 (15.20)	10.36 (14.04)	14.47 (19.62)

4 bolt flange - SAE J744

Pump reference	Weight		Overhang torque	
	without inlet fitting lbs (kg)	with inlet fitting 2" lbs (kg)	without inlet fitting lbf ft (N.m)	with inlet fitting 2" lbf ft (N.m)
XAi 18 - 4 bolts	28.77 (13.05)	29.76 (13.50)	12.27 (16.64)	12.69 (17.21)
XAi 25 - 4 bolts	28.77 (13.05)	29.76 (13.50)	12.27 (16.64)	12.69 (17.21)
XAi 32 - 4 bolts	32.74 (14.85)	33.73 (15.30)	14.14 (19.17)	14.57 (19.75)
XAi 41 - 4 bolts	32.85 (14.90)	33.84 (15.35)	14.19 (19.24)	14.62 (19.82)
XAi 50 - 4 bolts	32.63 (14.80)	33.62 (15.25)	14.79 (20.05)	15.24 (20.66)
XAi 63 - 4 bolts	32.74 (14.85)	33.73 (15.30)	14.84 (20.12)	15.29 (20.73)

► Dimensions with by-pass valve

Pump reference	A	B	C	D	E	F	G	H	J
XAi 18 / 25	11.43 (290.4)	8.81 (223.9)	8.00 (203.2)	5.20 (132.1)	4.53 (115)	3.84 (97.6)	3/4" - 16UNF - 2B	2.13 (54)	4.25 (108)
XAi 32	11.67 (296.5)	9.06 (230)	8.24 (209.2)	5.41 (137.3)	4.73 (120.1)	4.04 (102.7)	3/4" - 16UNF - 2B	2.13 (54)	4.25 (108)
XAi 41	11.67 (296.5)	9.06 (230)	8.24 (209.2)	5.41 (137.3)	4.73 (120.1)	4.04 (102.7)	1 1/16" - 16UNF - 2B	2.13 (54)	4.25 (108)
XAi 50 / 63	12.13 (308.2)	9.52 (241.7)	8.70 (221)	5.79 (147)	5.11 (129.9)	4.43 (112.5)	1 1/16" - 16UNF - 2B	2.13 (54)	4.25 (108)

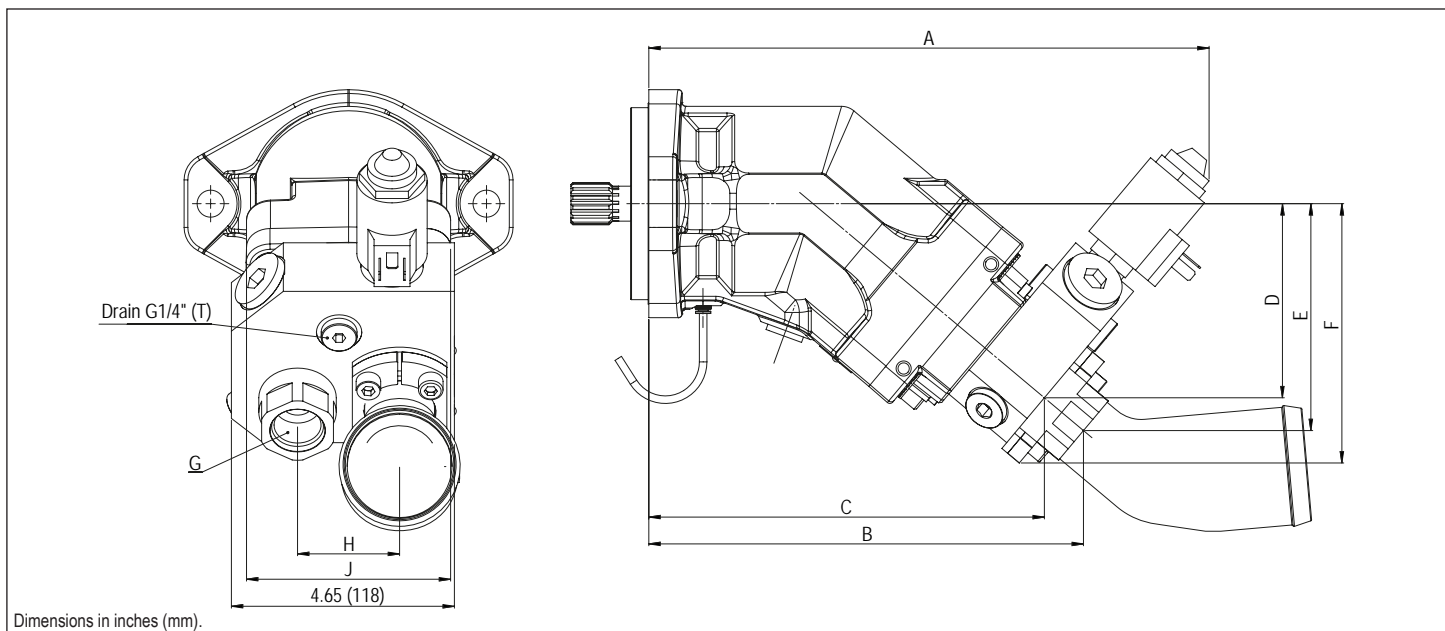

A passion for hydraulics

HYDRO LEDUC SAS
Head Office & factory
BP 9 - F-54122 AZERAILLES
FRANCE
Tél . +33 (0)3 83 76 77 40
Fax +33 (0)3 83 75 21 58

HYDRO LEDUC GmbH
Am Ziegelplatz 20
D-77746 SCHUTTERWALD
DEUTSCHLAND
Tel. +49 (0) 781-9482590
Fax + 49 (0) 781-9482592

HYDRO LEDUC AB
Betongvägen 11
461 38 TROLLHÄTTEN
SWEDEN
Tel. 46 (0) 520 10 820

HYDRO LEDUC BV
Graaf Engelbertlaan 75
4837 DS Breda
THE NETHERLANDS
+31 6 202 40 651

HYDRO LEDUC N.A. Inc.
Grand Parkway Industrial Park
23549 Clay Road
KATY, TX 77493
USA
Tel. +1 281 679 9654
Fax +1 832 321 3553

 **HYDRO
LEDUC**
make it simple

www.hydroleduc.com



HYDRO LEDUC
SAS au capital de 4 065 000 €
EORI FR31902742100019
RC Nancy B 319 027 421
contact@hydroleduc.com

US_TRUCK PUMPS_20191206